

My Tikz Learning

Yangyang Li

August 12, 2023

Contents

1	Case transformer	3
2	Case hello world	4
3	Case example1	5
4	Case image-overlay	6
5	Case shape	7
6	Case plot3d	8
7	Case qual graph	9
8	Case plot function	9
9	Case tree2	10
10	Case curve	10
11	Case plot func	11
12	Case tree1	11
13	Case latex graphics tikz book5	12
14	Case latex graphics tikz book4	12
15	Case latex graphics tikz book1	12
16	Case colored diagram	12
17	Case neuron	13
18	Case latex graphics tikz book3	13
19	Case latex graphics tikz book2	13
20	Case diamond	14

1 Case transformer

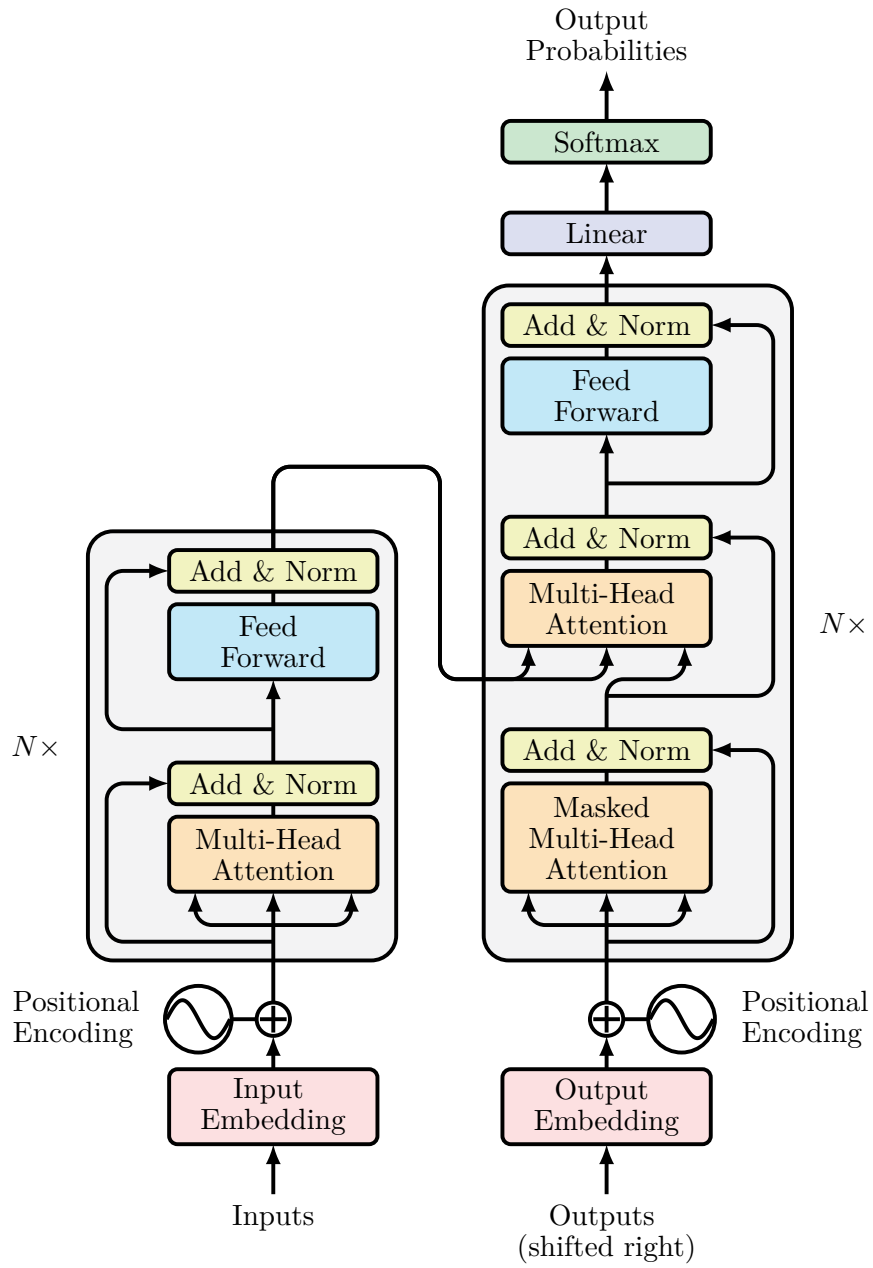

Figure 1: transformer code

2 Case hello world

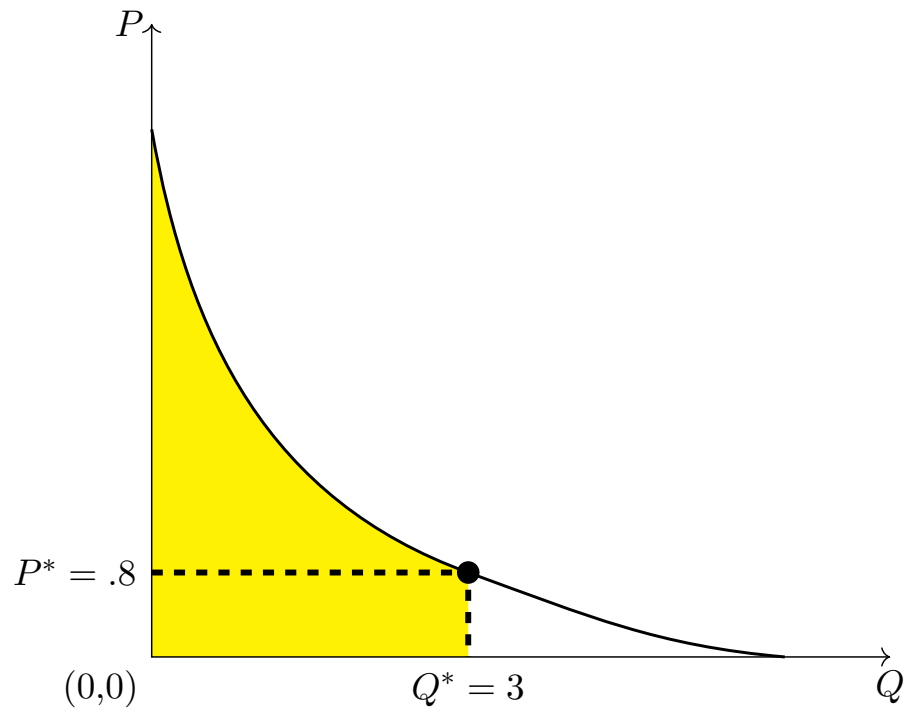

Figure 2: hello world `code`

3 Case example1

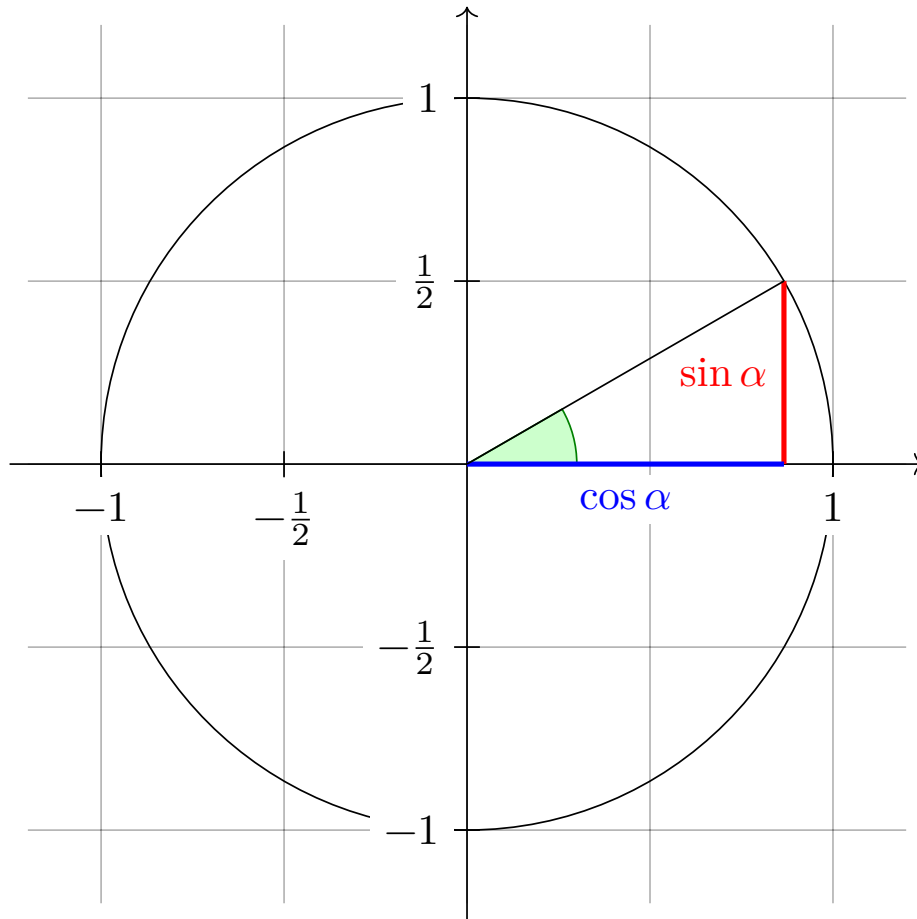

Figure 3: example1 `code`

4 Case image-overlay

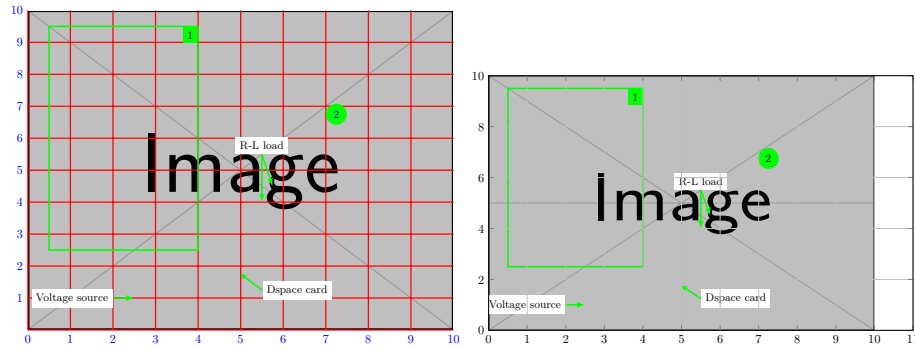

Figure 4: image-overlay code

5 Case shape

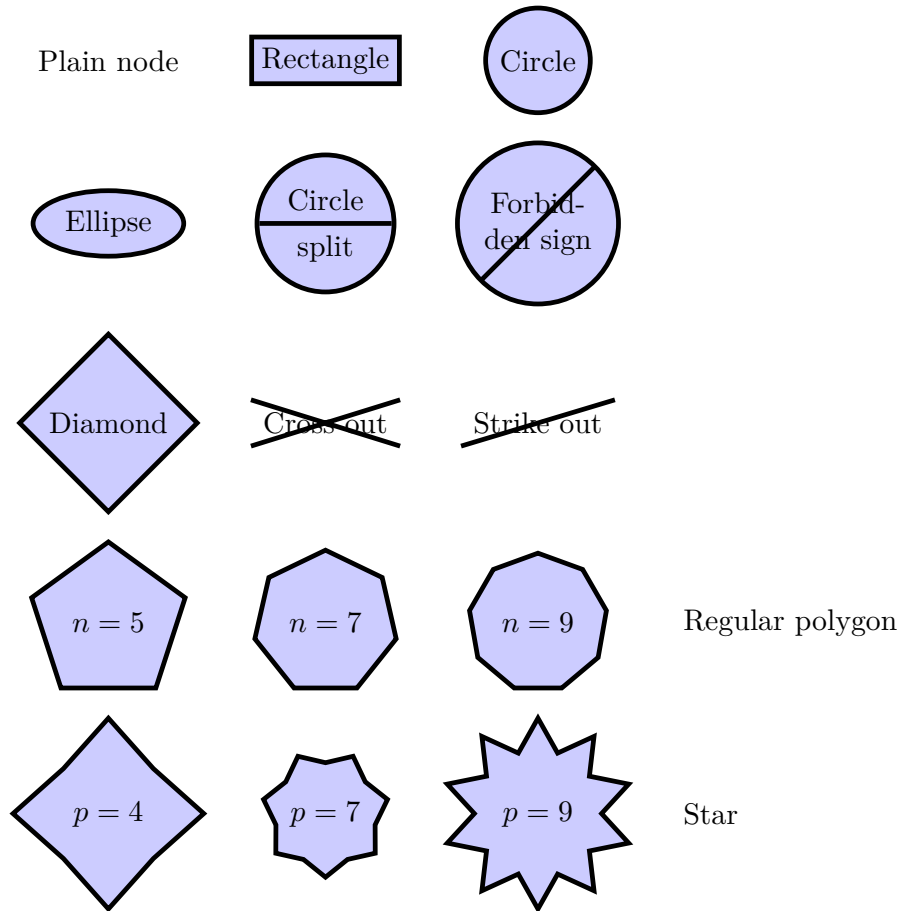

Figure 5: shape `code`

6 Case plot3d

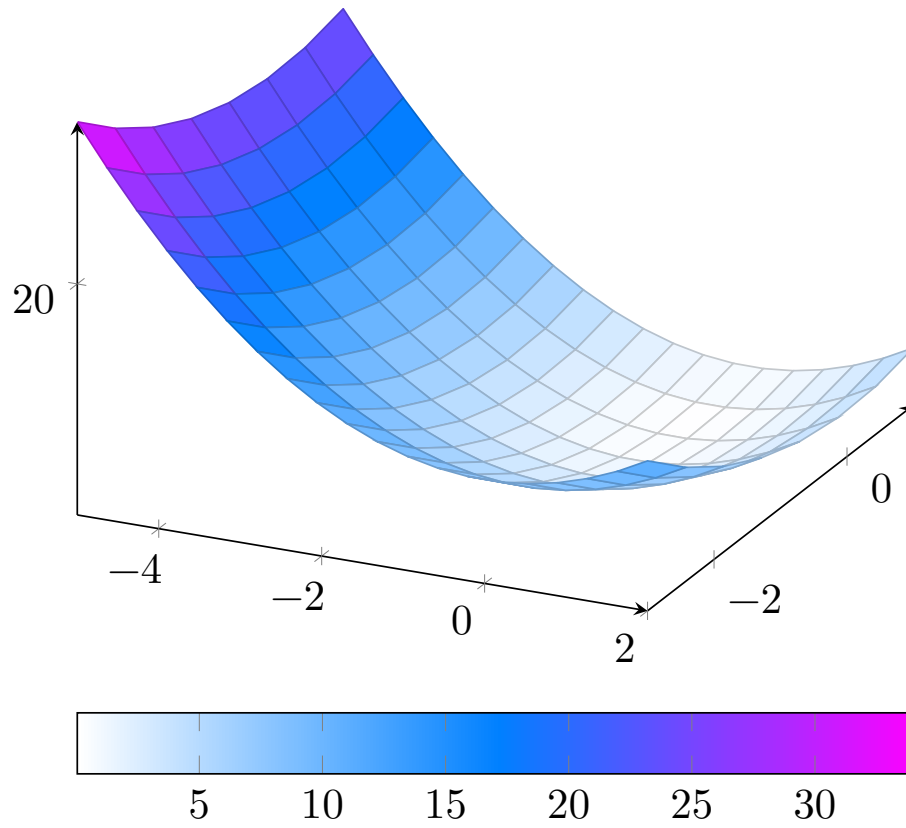

Figure 6: plot3d `code`

7 Case qual graph

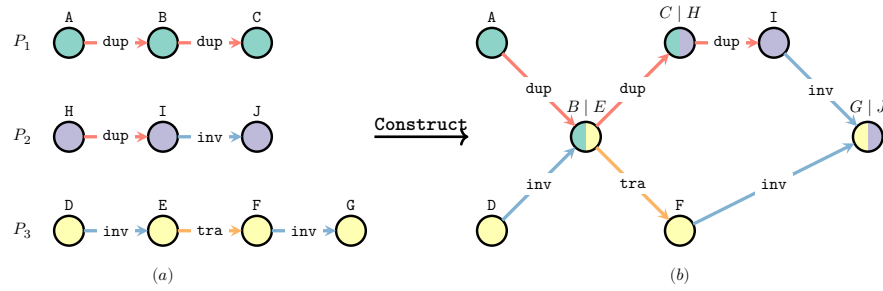

Figure 7: qual graph code

8 Case plot function

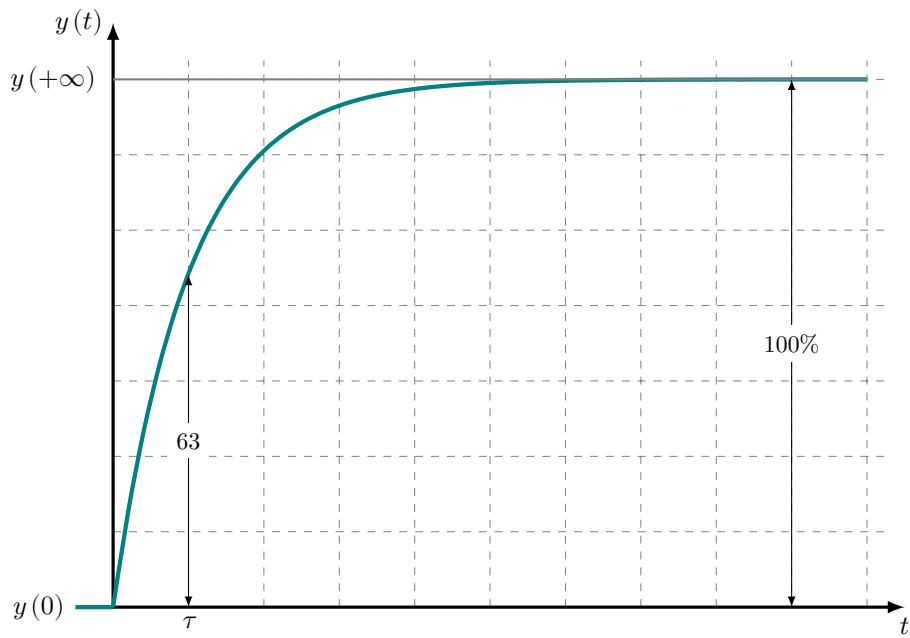

Figure 8: plot function code

9 Case tree2



Figure 9: tree2 code

10 Case curve

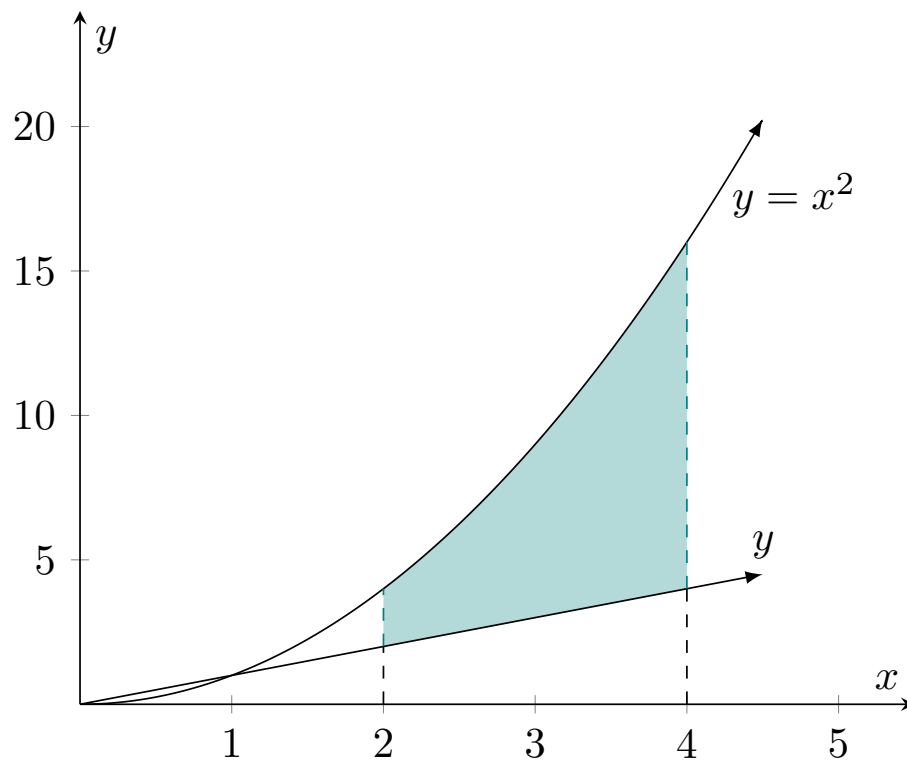

Figure 10: curve code

11 Case plot func

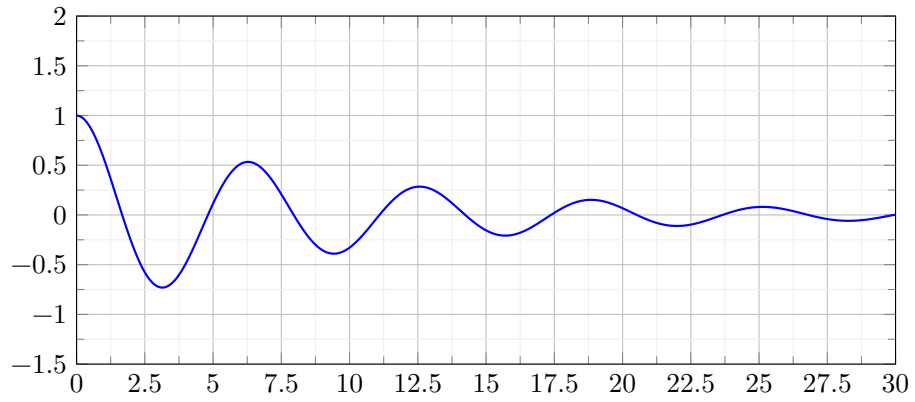

Figure 11: plot func `code`

12 Case tree1

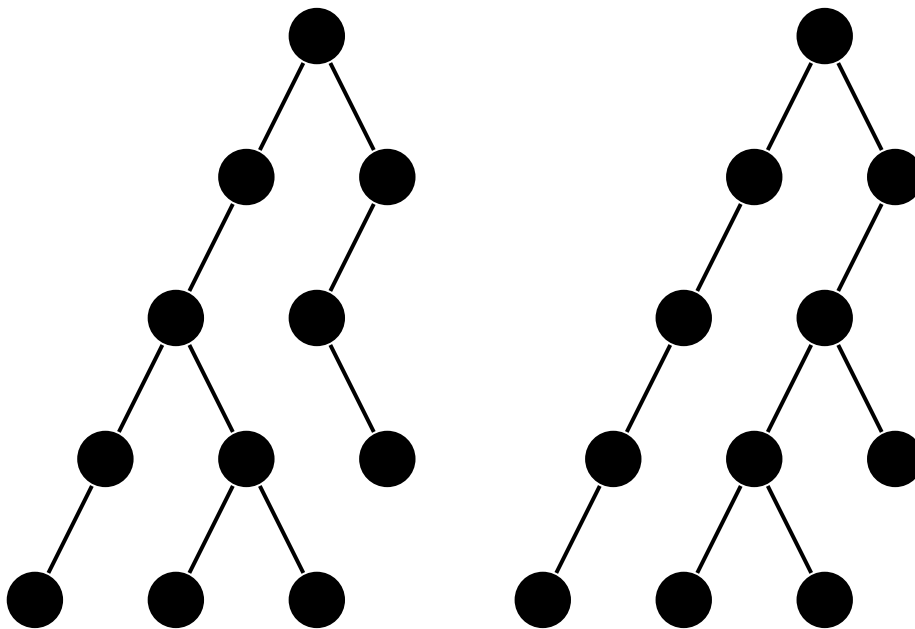

Figure 12: tree1 `code`

13 Case latex graphics tikz book5



Figure 13: latex graphics tikz book5 [code](#)

14 Case latex graphics tikz book4

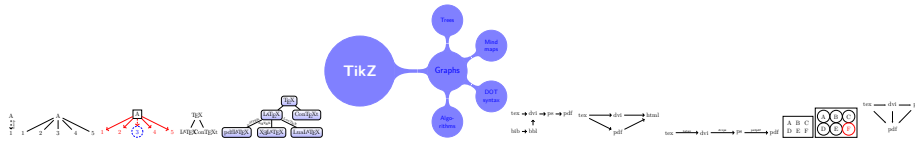

Figure 14: latex graphics tikz book4 [code](#)

15 Case latex graphics tikz book1

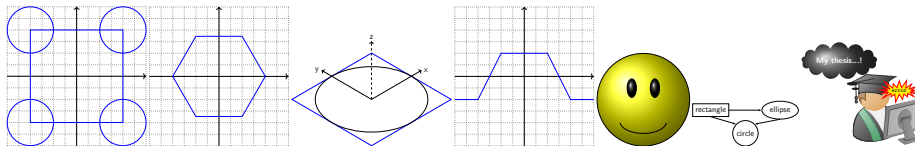

Figure 15: latex graphics tikz book1 [code](#)

16 Case colored diagram

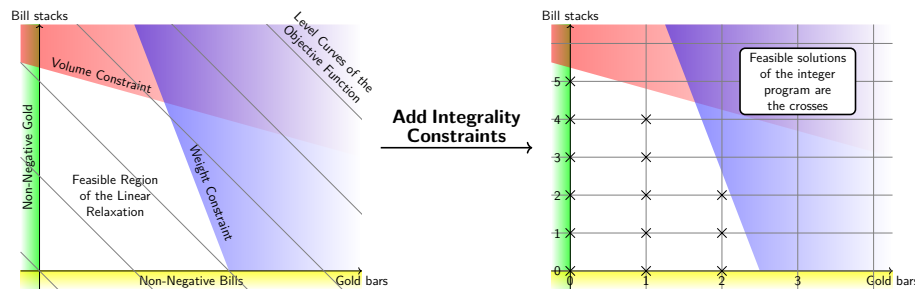

Figure 16: colored diagram [code](#)

17 Case neuron

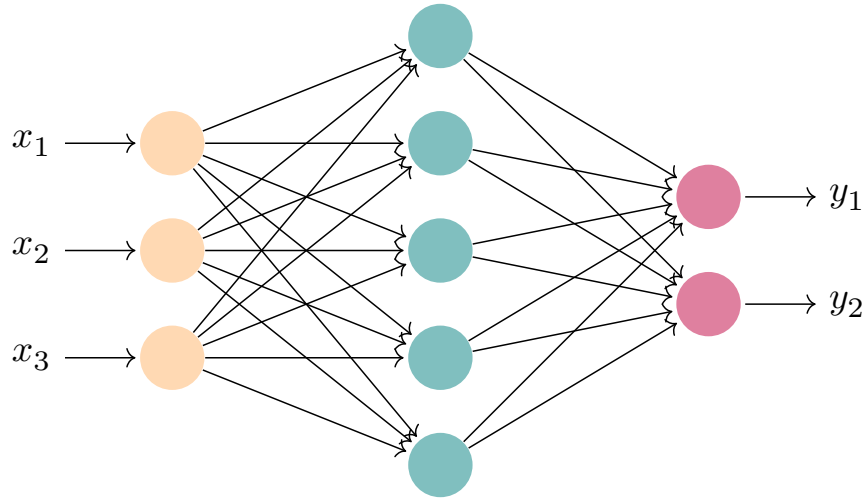

Figure 17: neuron `code`

18 Case latex graphics tikz book3

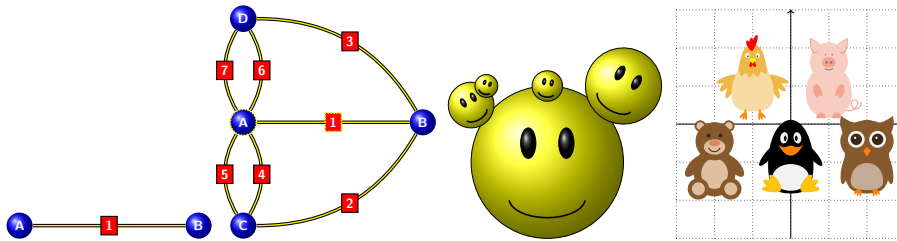

Figure 18: latex graphics tikz book3 `code`

19 Case latex graphics tikz book2



Figure 19: latex graphics tikz book2 `code`

20 Case diamond

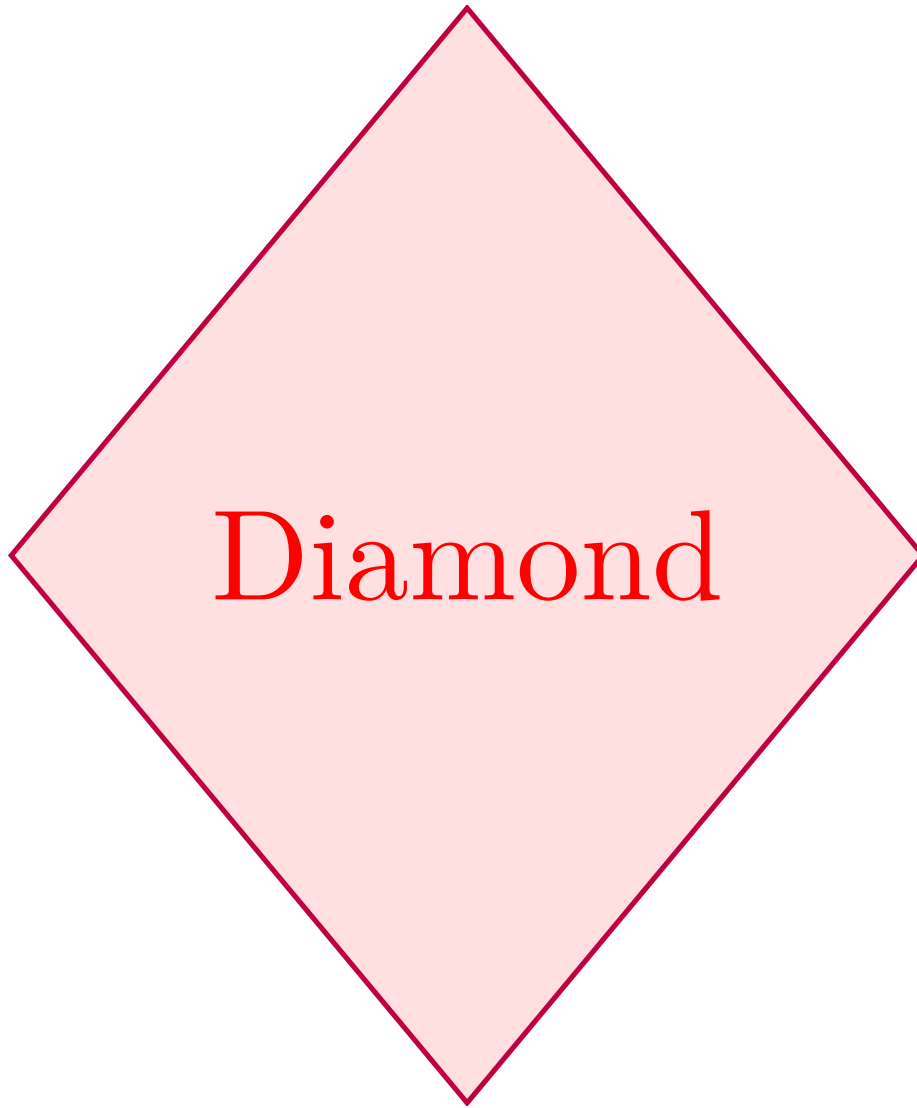

Figure 20: diamond `code`